

# User's Manual

# RadiForce® GS510-BL GS510-CL GS510-BLG GS510-CLG

Monochrome LCD Monitor

It shall be assured that the final system is in compliance to IEC60601-1-1 requirements.



## SAFETY SYMBOLS

This manual uses the safety symbols below. They denote critical information. Please read them carefully.



### WARNING

Failure to abide by the information in a WARNING may result in serious injury and can be life threatening.



### CAUTION

Failure to abide by the information in a CAUTION may result in moderate injury and/or property or product damage.



Indicates a prohibited action.



Indicates to ground for safety.

- Power supplied equipment can emit electromagnetic waves, that could influence, limit or result in malfunction of the monitor. Install the equipment in a controlled environment, where such effects are avoided.
- This is a monitor intended for use in a medical image system.
- Product specifications may vary depending on the region. Confirm the specifications in the manual written in the language of the region of purchase.

---

Copyright© 2006 EIZO NANA O CORPORATION All rights reserved. No part of this manual may be reproduced, stored in a retrieval system, or transmitted, in any form or by any means, electronic, mechanical, or otherwise, without the prior written permission of EIZO NANA O CORPORATION.

EIZO NANA O CORPORATION is under no obligation to hold any submitted material or information confidential unless prior arrangements are made pursuant to EIZO NANA O CORPORATION's receipt of said information. Although every effort has been made to ensure that this manual provides up-to-date information, please note that EIZO monitor specifications are subject to change without notice.

---

---

Apple and Macintosh are registered trademarks of Apple Computer, Inc.  
VESA is a registered trademark of Video Electronics Standards Association.  
Windows is a registered trademark of Microsoft Corporation.  
RealVision is a registered trademark of RealVision Inc.  
Matrox is a registered trademark of Matrox Electronic Systems Ltd.  
PowerManager, RadiCS and RadiNET are trademarks of EIZO NANA O CORPORATION.  
ScreenManager, RadiForce and EIZO are registered trademarks of EIZO NANA O CORPORATION in Japan and other countries.

---

---

# TABLE OF CONTENTS

 <b>PRECAUTIONS</b> .....	<b>4</b>
<b>1. INTRODUCTION</b> .....	<b>9</b>
1-1. Features .....	9
1-2. Package Contents.....	9
1-3. Controls & Connectors .....	10
<b>2. CABLE CONNECTIONS</b> .....	<b>12</b>
<b>3. MENUS &amp; FUNCTIONS</b> .....	<b>15</b>
3-1. ScreenManager .....	15
3-2. Other Useful Functions.....	17
3-3. Power-save Setup.....	19
<b>4. MAKING USE OF USB (Universal Serial Bus)</b> .....	<b>20</b>
<b>5. ATTACHING AN ARM</b> .....	<b>22</b>
<b>6. TROUBLESHOOTING</b> .....	<b>23</b>
<b>7. CLEANING</b> .....	<b>26</b>
<b>8. SPECIFICATIONS</b> .....	<b>27</b>
<b>9. GLOSSARY</b> .....	<b>30</b>

# PRECAUTIONS





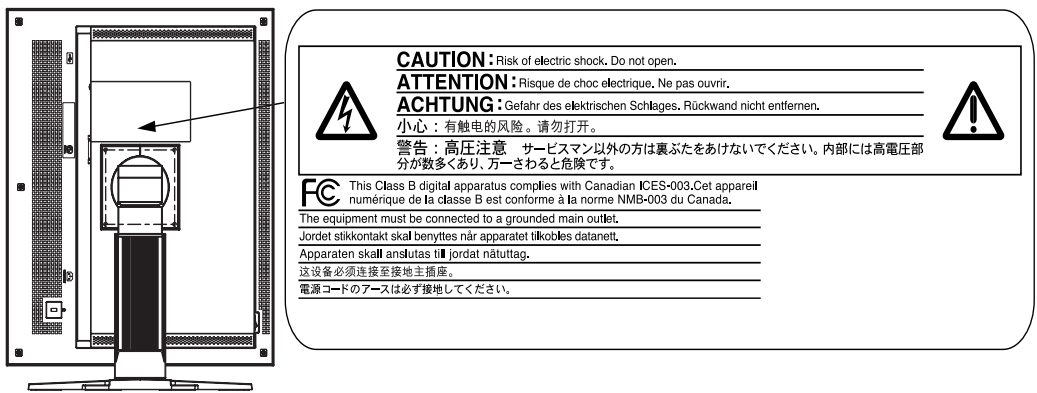

## IMPORTANT!

- This product has been adjusted specifically for use in the region to which it was originally shipped. If operated outside the region to which it was originally shipped, the product may not perform as stated in the specifications.
- To ensure personal safety and proper maintenance, please read this section and the caution statements on the unit (refer to the figure below).

### [Location of the Caution Statements]



### [Symbols on the unit]

Symbol	Location	This symbol indicates
	Rear	Main power switch Press to turn the monitor's main power off.
	Rear	Main power switch Press to turn the monitor's main power on.
	Front Control panel	Power switch Touch to turn the monitor's power on or off.
	Rear Name Plate	Alternating current
	Rear	Alerting electrical hazard
	Rear	Caution Refer to SAFETY SYMBOLS section in this manual.

## WARNING

**If the unit begins to emit smoke, smells like something is burning, or makes strange noises, disconnect all power connections immediately and contact your dealer for advice.**

Attempting to use a malfunctioning unit may result in fire, electric shock, or equipment damage.

**Do not open the cabinet or modify the unit.**

Opening the cabinet or modifying the unit may result in fire, electric shock, or burn.



**Refer all servicing to qualified service personnel.**

Do not attempt to service this product yourself as opening or removing covers may result in fire, electric shock, or equipment damage.

**Keep small objects or liquids away from the unit.**

Small objects accidentally falling through the ventilation slots into the cabinet or spillage into the cabinet may result in fire, electric shock, or equipment damage.

If an object or liquid falls/spills into the cabinet, unplug the unit immediately. Have the unit checked by a qualified service engineer before using it again.

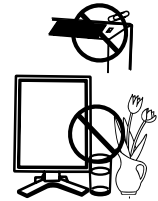

**Place the unit at the strong and stable place.**

A unit placed on an inadequate surface may fall and result in injury or equipment damage.

If the unit falls, disconnect the power immediately and ask your dealer for advice. Do not continue using a damaged unit. Using a damaged unit may result in fire or electric shock.



**Set the unit in an appropriate location.**

Not doing so may result in fire, electric shock, or equipment damage.

- \* Do not place outdoors.
- \* Do not place in the transportation system (ship, aircraft, trains, automobiles, etc.)
- \* Do not place in a dusty or humid environment.
- \* Do not place in a location where the steam comes directly on the screen.
- \* Do not place near heat generating devices or a humidifier.
- \* Do not place in an inflammable gas environment.

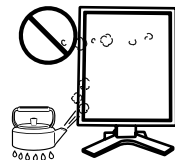

**To avoid danger of suffocation, keep the plastic packing bags away from babies and children.**

**Use the enclosed power cord and connect to the standard power outlet of your country.**

Be sure to remain within the rated voltage of the power cord.

Not doing so may result in fire or electric shock.

## **WARNING**

---

### **To disconnect the power cord, grasp the plug firmly and pull.**

Tugging on the cord may damage and result in fire or electric shock.

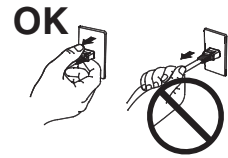

---

### **The equipment must be connected to a grounded main outlet.**

Not doing so may result in fire or electric shock.



---

### **Use the correct voltage.**

- \* The unit is designed for use with a specific voltage only. Connection to another voltage than specified in this User's Manual may cause fire, electric shock, or equipment damage.
- \* Do not overload your power circuit, as this may result in fire or electric shock.

---

### **Handle the power cord with care.**

- \* Do not place the cord underneath the unit or other heavy objects.
- \* Do not pull on or tie the cord.

If the power cord becomes damaged, stop using it. Use of a damaged cord may result in fire or electric shock.

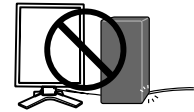

---

### **Never touch the plug and power cord if it begins to thunder.**

Touching them may result in electric shock.

---

### **When attaching an arm stand, please refer to the user's manual of the arm stand and install the unit securely.**

Not doing so may cause the unit to come unattached, which may result in injury or equipment damage. When the unit is dropped, please ask your dealer for advice. Do not continue using a damaged unit. Using a damaged unit may result in fire or electric shock. When reattaching the tilt stand, please use the same screws and tighten them securely.

---

## WARNING

### **Do not touch a damaged LCD panel directly with bare hands.**

The liquid crystal which leaks from the panel is poisonous if it enters the eyes or mouth.

If any part of the skin or body comes in direct contact with the panel, please wash thoroughly. If some physical symptoms result, please consult your doctor.



### **Follow local regulation or laws for safe disposal.**

The backlight of the LCD panel contains mercury.

## CAUTION

### **Handle with care when carrying the unit.**

Disconnect the power cord and cables when moving the unit. Moving the unit with the cord attached is dangerous. It may result in injury.

### **When handling the unit, grip the bottom of the unit firmly with both hands ensuring the panel faces outward before lifting.**

Dropping the unit may result in injury or equipment damage.



### **Do not block the ventilation slots on the cabinet.**

- \* Do not place any objects on the ventilation slots.
- \* Do not install the unit in a closed space.
- \* Do not use the unit laid down or upside down.

Blocking the ventilation slots prevents proper airflow and may result in fire, electric shock, or equipment damage.



### **Do not touch the plug with wet hands.**

Doing so may result in electrical shock.



### **Use an easily accessible power outlet.**

This will ensure that you can disconnect the power quickly in case of a problem.

### **Periodically clean the area around the plug.**

Dust, water, or oil on the plug may result in fire.

### **Unplug the unit before cleaning it.**

Cleaning the unit while it is plugged into a power outlet may result in electric shock.

**If you plan to leave the unit unused for an extended period, disconnect the power cord from the wall socket after turning off the power switch for the safety and the power conservation.**

## LCD Panel

---

---

The screen may have defective pixels. These pixels may appear as slightly light or dark area on the screen. This is due to the characteristics of the panel itself, and not the product.

---

The backlight of the LCD panel has a fixed life span. When the screen becomes dark or begins to flicker, please contact your dealer.

---

Do not press on the panel or edge of the frame strongly, as this may result in damage to the screen. There will be prints left on the screen if the pressed image is dark or black. If pressure is repeatedly applied to the screen, it may deteriorate or damage your LCD panel. Leave the screen white to decrease the prints.

---

Do not scratch or press on the panel with any sharp objects, such as a pencil or pen as this may result in damage to the panel. Do not attempt to brush with tissues as this may scratch the LCD panel.

---

When the screen image is changed after displaying the same image for extended periods of time, an afterimage may appear. Use the screen saver or timer to avoid displaying the same image for extended periods of time.

---

When the monitor is cold and brought into a room or the room temperature goes up quickly, dew condensation may occur inside and outside the monitor. In that case, do not turn the monitor on and wait until dew condensation disappears, otherwise it may cause some damages to it.

---



# 1. INTRODUCTION

Thank you for choosing an EIZO Monochrome Monitor.

## 1-1. Features

- DVI Digital input compliant (p.30 ; for TMDS, p.30)
- [Horizontal scanning frequency] 103.9 ± 4 kHz  
[Vertical scanning frequency] 50.06 ± 3 Hz  
[Resolution] 5M pixels (Portrait: 2048 × 2560 dots (H × V))
- USB (Universal Serial Bus) hub support (p.20)
- Utility software “ScreenManager Pro for Medical”, which enables control of the monitor from a Windows PC with a mouse or keyboard (refer to the EIZO LCD Utility Disk).
- Monitor stand adjustable for different heights
- Slim bezel

### **NOTE**

- Regarding the scanning frequency, the GS510-BL/GS510-CL/GS510-BLG/GS510-CLG supports only the exclusive timing.

## 1-2. Package Contents

Please contact your local dealer for assistance if any of the listed items are missing or damaged.

- |                             |  |
|-----------------------------|--|
| • LCD Monitor <sup>*1</sup> | • EIZO LCD Utility Disk                                |
| • Power Cord                | • User’s Manual  |
| • Signal Cable (FD-C39)     | • LIMITED WARRANTY                                     |
| • EIZO USB Cable (MD-C93)   | • Cleaning Kit “ScreenCleaner”<br>(GS510-BLG/CLG only) |

<sup>\*1</sup> The landscape position is the default monitor orientation. For the portrait position, rotate the monitor ninety degrees counter-clockwise before installing it.

### **NOTE**

- Please retain the packing materials for future transport of the monitor.

# 1-3. Controls & Connectors

## Front

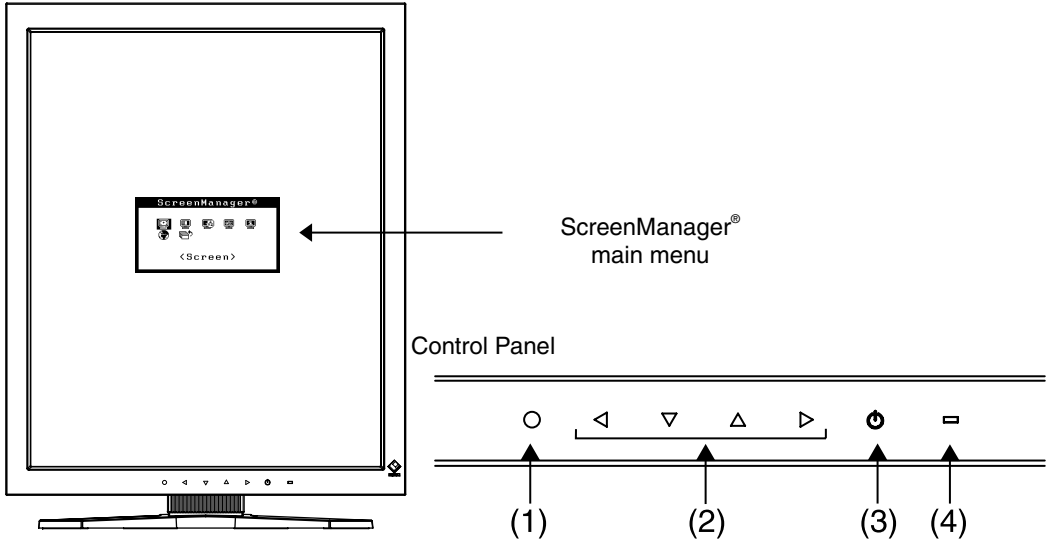

- (1) ENTER      Enter Switch
- (2) ◀▶▶▶      Directing Switches (Left, Down, Up, Right)<sup>1</sup>
- (3) ⏻          Power Switch
- (4) ◻          Power Indicator<sup>2</sup>





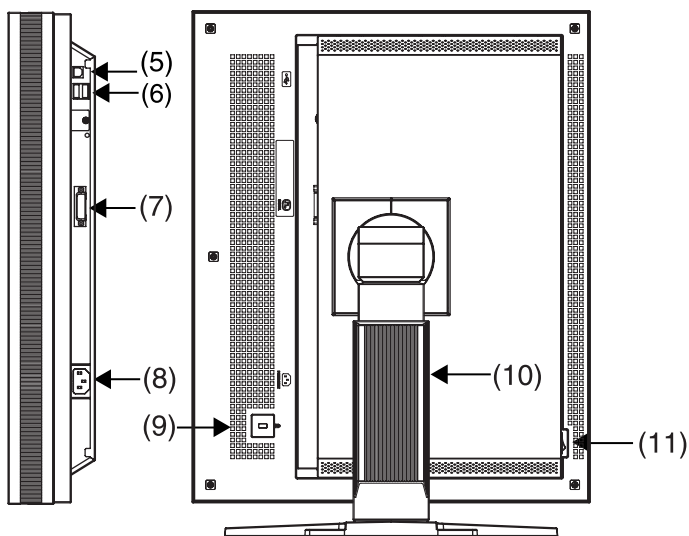

Green	Operational
Orange	Power saving
Flashing orange (2 times for each)	Power saving(Off mode)
Flashing orange slowly	Power off (Main power is on)
Off	Main Power off

<sup>1</sup> These switches can be changed to Up, Left, Right and Down in case of selecting "Landscape" in <Orientation> of the ScreenManager <Others> menu (p.16).

<sup>2</sup> To disable the power indicator while the monitor is operational, see p.18. For power indicator status when using the "Off Timer," see p.17.

## Side / Rear



- (5)  USB upstream port (x 1)
- (6)  USB downstream ports (x 2)
- (7)  DVI-D input connector
- (8)  Power connector
- (9)  Security lock slot<sup>\*3</sup>
- (10)  Monitor stand with adjustable height (detachable)<sup>\*4</sup>
- (11)  Main Power Switch

<sup>\*3</sup> Allows for connection of a security cable. This lock supports Kensington's MicroSaver security system. For further information, please consult :

Kensington Technology Group  
 2855 Campus Drive, San Mateo, CA 94403 USA  
 Tel.: 800-650-4242, x3348, Intl: 650-572-2700, x3348  
 Fax: 650-572-9675  
<http://www.kensington.comT/>

<sup>PP\*4</sup> The LCD monitor can be oriented in the landscape position. (It can rotate clockwise ninety degrees.)  
 By removing the monitor stand, the LCD monitor can be used with the optional arm stand (p.22).

# 2. CABLE CONNECTIONS

**NOTE**

- Be sure that the power switches of both the PC and the monitor are OFF.
- Refer also to the PC user's manual when connecting the monitor.

1. Rotate the monitor ninety degrees counter-clockwise into the portrait position.

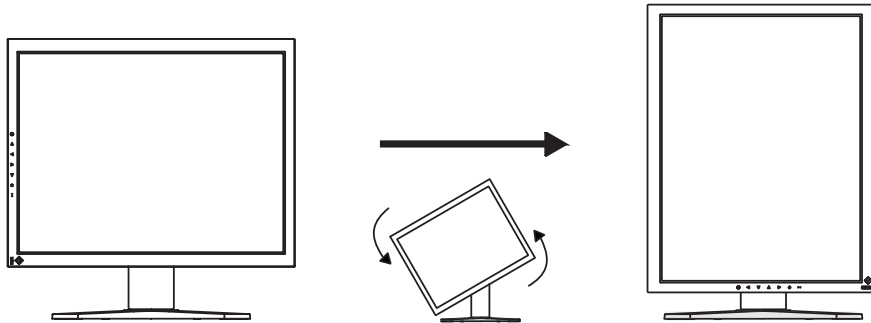

2. Connect the signal cable to the DVI-D input connector on the rear of the monitor and to the video output connector on the PC.

After connecting, secure the cable connectors with the attached screw-in fasteners.

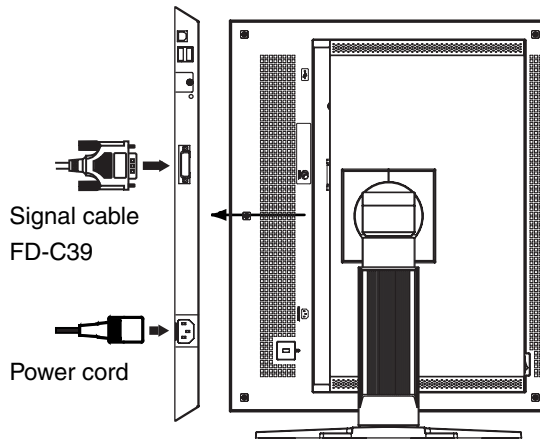

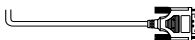
Signal Cable	Connector on PC	PC
Signal cable (FD-C39) 	Video output connector	Exclusive graphics board (p.28)

**NOTE**

- The monitor is not compatible with a color graphics board.

3. Connect the power cord to the power connector on the rear of the monitor.
4. Thread the power cord and signal cable through the cable holder on the rear of the monitor stand.

**NOTE**

- When threading the cables through the cable holder, lead them to the cable entrance side and pinch the projection to open the cable entrance.
- It is recommended that some slack be left in the cables to allow for smooth adjustment of the monitor stand and easy rotation between the portrait and landscape positions.

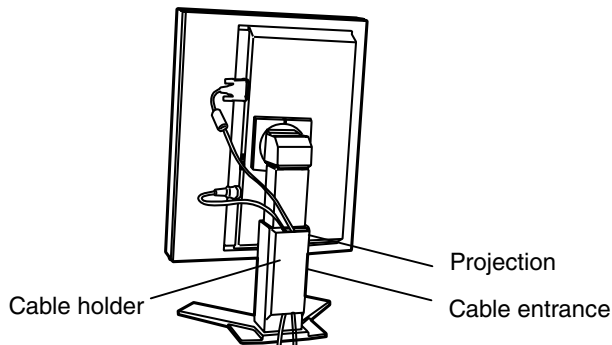

5. Connect the other end of the power cord to a power outlet.

**⚠ WARNING**

**Use the enclosed power cord and connect to the standard power outlet of your country.**

Be sure to remain within the rated voltage of the power cord.  
Not doing so may result in fire or electric shock.

**The equipment must be connected to a grounded main outlet.**

Not doing so may result in fire or electric shock.



6. Turn on the monitor's power by touching the power switch.  
The monitor's power indicator will light up green.

**7. Turn on the PC's power.**

If an image does not appear, refer to “6. TROUBLESHOOTING” (p.23) for additional advice.

When finished, turn off the PC and the monitor.

**NOTE**

- Adjust the brightness of the screen depending on the brightness of your environment.
- Be sure to take adequate rests. A 10-minute rest period each hour is suggested.

**8. When using the software "ScreenManager Pro for Medical," connect the monitor to a USB compliant Windows computer (or other USB hub) with a USB cable.**

Refer to “4. MAKING USE OF USB (Universal Serial Bus)” (p.20).

# 3. MENUS & FUNCTIONS

## 3-1. ScreenManager

Screen adjustments and settings can be performed with the monitor controls.

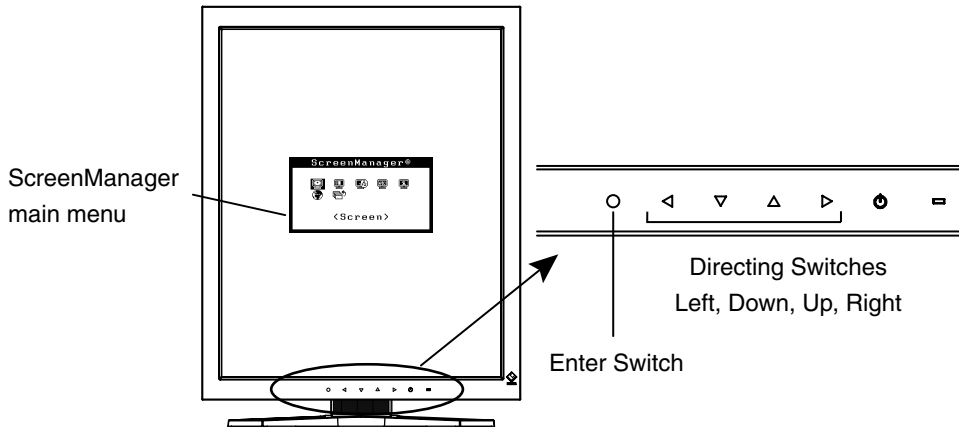

### How to use the ScreenManager

#### [Entering the ScreenManager]

- (1) Touch the enter switch.

#### [Making adjustments and settings]

- (1) Select the desired submenu icon with the directing switches and touch the enter switch.
- (2) Select the desired setting icon with the directing switches and touch the enter switch.
- (3) Make any required adjustments with the directing switches and touch the enter switch.

#### [Exiting the ScreenManager]

- (1) To return to the main menu, select the <Return> icon , followed by the enter switch.
- (2) To exit the ScreenManager, select the <Exit> icon or touch the Down directing switch twice, followed by the enter switch.

#### **NOTE**

- Touching the enter switch twice quickly also exits the ScreenManager.

## ScreenManager Menus and Settings

The following table briefly explains each of the menus and settings in the ScreenManager.

Main menu	Sub menu		Reference
Screen	Brightness <sup>*1</sup>		Control the brightness for the entire screen.
	Unlock		Unlock the locked functions. (p.18)
LUT Setting	Default / Normal <sup>*2</sup> / Custom <sup>*3</sup>		Set the LUT (Look-up table) (p.30) setting.
PowerManager	DVI DMPM		Refer to “3-3. Power-save Setup” (p.19).
Others	Off Timer		Turn off the monitor after a specified time. (p.17)
	Menu Settings	Menu Position	Adjust the menu position.
		Menu Off Timer	Set the menu displaying time.
	Orientation		Change the orientation of the menu for monitor’s portrait position.
	Power Indicator		Disable the green power indicator.
	Reset		Restore the factory default settings. (p.28)
Information	Information		View the ScreenManager settings, model name, serial number, and usage time <sup>*4</sup> .
Language	English/Japanese		Select the language of the ScreenManager menus.

<sup>\*1</sup> Directly touching the Directing Switch on the control panel also adjusts the brightness.

<sup>\*2</sup> Set to the “Normal” in case of using the monitor with the original characteristic of panel.

<sup>\*3</sup> “Custom” automatically stores the customized data after the calibration is performed.

<sup>\*4</sup> Due to factory inspection, the usage time may not be “0 H” at time of shipping.



## 3-2. Other Useful Functions

### Adjustment Lock

Use this function to prevent any accidental changes to the monitor settings. The following table shows which functions the adjustment lock affects.

Locked functions	<ul style="list-style-type: none"> <li>• Display, adjustment, and setting of the ScreenManager</li> <li>• Adjustment of brightness by the Directing Switch</li> </ul>
------------------	---

#### [How to lock]

- (1) Turn off the monitor power by touching the power switch.
- (2) Touch the power switch while touching the enter switch.

#### [How to unlock]

- (1) Turn off the monitor power by touching the power switch.
- (2) Touch the power switch while touching the enter switch, and then turn on the monitor again. The adjustment lock is released.

### Off Timer

The off timer function causes the monitor to turn off automatically after a predetermined amount of time has lapsed. This function was created to reduce the afterimages particular to LCD monitors, which appear when the screen is left on for long periods without use.

#### [How to set]

- (1) Select <Off Timer> in the ScreenManager <Others> menu.
- (2) Select “Enable” and touch the Right and Left directing switches to adjust the operating time (1 to 23 hours).

#### [Off timer system]

PC	Monitor	Power Indicator
Operating time (1H - 23H)	Operational	Green
Last 15 min. in operating time	Advance Notice <sup>*1</sup>	Flashing green
Operating time expired	Power off	Flashing orange slowly

<sup>\*1</sup> By touching the power switch on the control panel during the Advance Notice period, the operating time can be reset to 90 minutes. Resetting can be performed an unlimited number of times.

#### [How to restore power]

Touch the power switch to return to a normal screen.

#### **NOTE**

- The off timer function works while the PowerManager is active, but there is no advance notice before the monitor's power is turned off.

## Power Indicator

Use the function to keep the power indicator without light while the monitor is operational. (The power indicator is set by default to light when the power is turned on.)

### [Procedure]

- (1) Select <Power Indicator> in the ScreenManager <Others> menu.
- (2) Select “Disable”.

## Unlock Function after Calibration

The calibration is available by using the specified optional calibration kit (p.28).

After the calibration, the functions below are automatically locked.

Locked function	<ul style="list-style-type: none"><li>• Brightness adjustment (including the adjustment by Left and Right Directing Switch on the control panel)</li><li>• LUT Setting</li></ul>
-----------------	--

To unlock these functions, use the ScreenManager.

### [How to unlock]

- (1) Select <Unlock> in <Screen> menu.
- (2) Select “Unlock”.

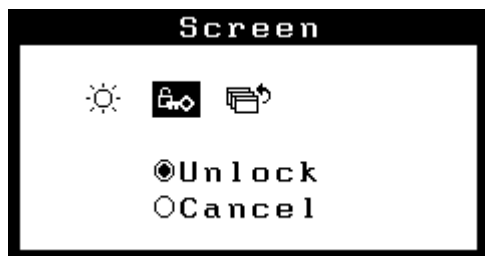

### **NOTE**

- Touching <Reset> in <Others> menu, locked functions are also unlocked.

## 3-3. Power-save Setup

Use the <PowerManager> menu in the ScreenManager to configure the power-save setup. This monitor complies with the “DVI DMPM” (p.30).

### **NOTE**

- Do your part to conserve energy, turn off the monitor when you are finished using it. Disconnecting the monitor from the power supply is recommended to save energy completely.
- Even if the monitor is in power-saving mode, USB compliant devices draw power when they are connected to the monitor's USB ports (both upstream and downstream). Therefore, the monitor's power consumption will change according to which devices are connected, even if the monitor is in power-saving mode.

### [Procedure]

- (1) Set the PC's power saving settings.
- (2) Select “DVI DMPM” in the <PowerManager> menu.

### [Power saving system]

PC	Monitor	Power Indicator
On	Operation	Green
Power saving	Power saving	Orange
Off mode	Power saving	Flashing orange (2 times for each)

### [Power Resumption Procedure]

- Click the mouse or press a key on the keyboard to return to a normal screen.
- Power on the PC to return a normal screen from the Off mode of the PC.

# 4. MAKING USE OF USB (UNIVERSAL SERIAL BUS)

This monitor provides a hub which supports the USB standard. When connecting to a USB compliant PC or another hub, the monitor functions as a hub to which the USB compliant peripherals can be easily connected.

## Required system environment

- PC equipped with USB ports or another USB hub connected to the USB compliant PC
- Windows 98/2000/Me/XP // Mac OS 8.5.1 or later
- EIZO USB Cable (MD-C93)

### NOTE

- The USB hub function may not work properly depending on the PC, OS or peripherals. Please consult the manufacturer of each device about the USB support.
- When the monitor is not on, the peripherals connected to the downstream ports will not operate.
- Even if the monitor is in a power saving mode, the devices connected to the monitor's USB ports (both the upstream and the downstream) will function.

## Connecting to the USB HUB

- 1.** Connect the monitor to the PC with the signal cable (p.12) first, then turn on the PC.
- 2.** Connect the upstream port of the monitor to the downstream port of the USB compliant PC or another hub by using the USB cable.

After connecting the USB cable, the USB function can be set up automatically.

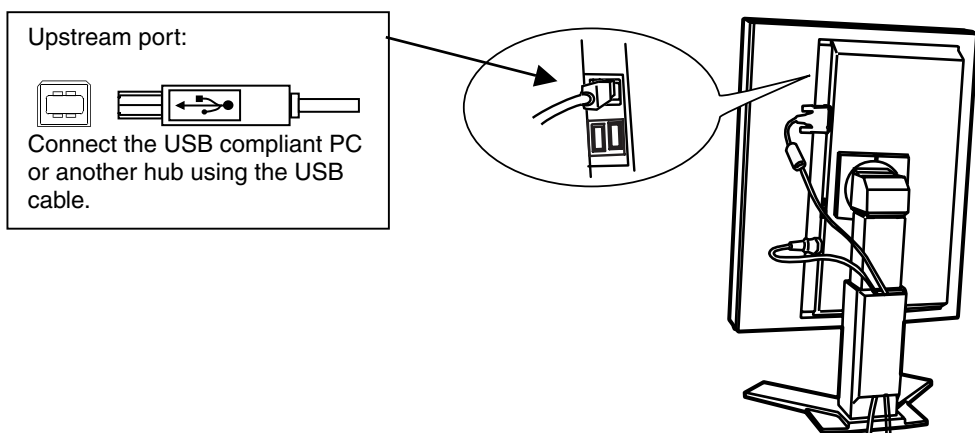

3. After setting up, the monitor's USB hub is available for connecting USB compliant peripherals to the downstream ports of the monitor.

### Connecting Examples

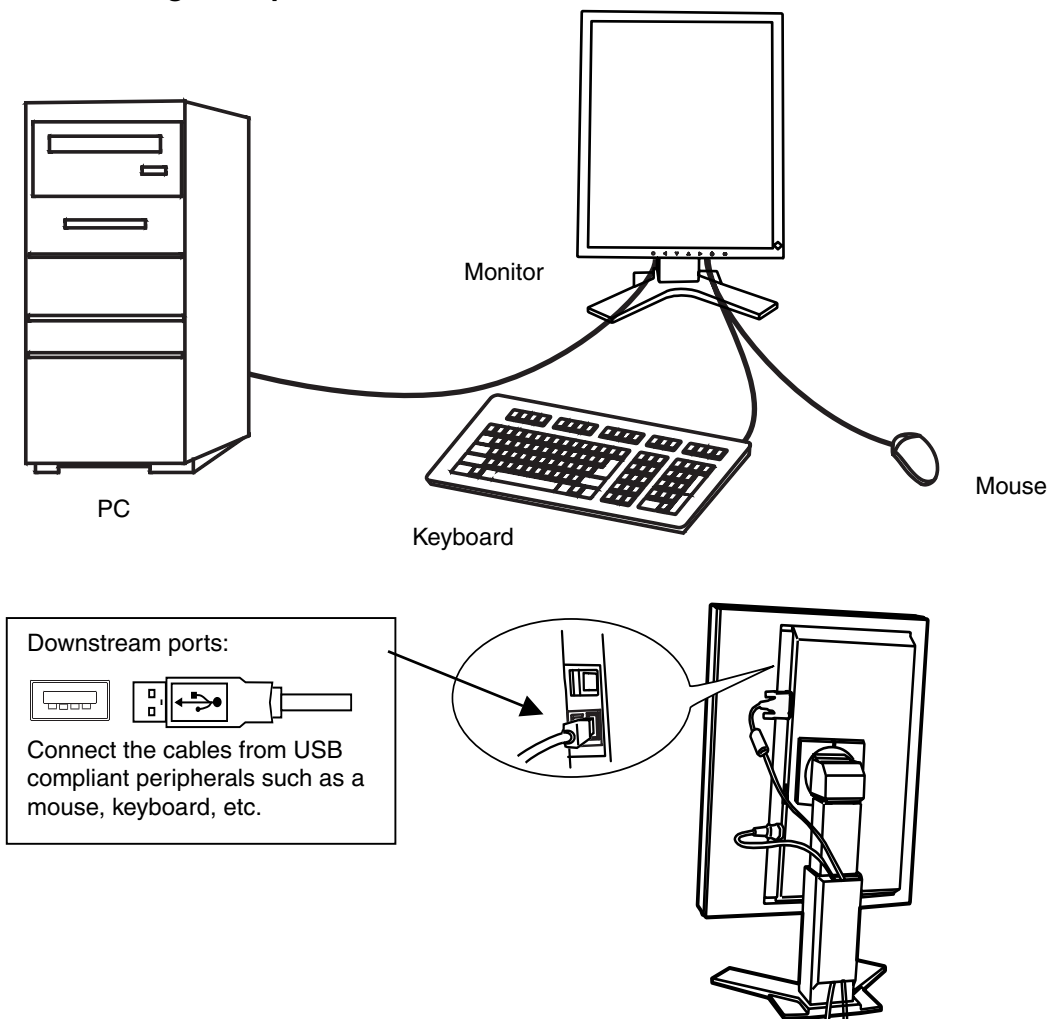

### ScreenManager Pro for Medical (for Windows)

For further details about the “ScreenManager Pro for Medical (for Windows)”, refer to the EIZO LCD Utility Disk.

# 5. ATTACHING AN ARM

The LCD monitor can be used with an arm by removing the tilt stand and attaching the arm or stand to the LCD monitor.

## NOTE

- If you will use the arm or stand of other manufacturers, confirm the followings to the manufacturers before selecting.
  - Hole spacing on the arm mounting: 100 mm x 100 mm (VESA compliant)
  - Supportable Weight: Total weight of the monitor (without stand) and attaching equipment such as a cable
  - TÜV/GS approved arm or stand
- Please connect cables after attaching an arm stand.

## Setup Procedure

- 1.** Hold the center of the stand mounting cover and slide them rightward or leftward to remove the mounting cover.
- 2.** Lay the LCD monitor down. Do not scratch the panel.
- 3.** Remove the tilt stand by loosening the screws.  
(4 pcs of M4 x 10mm )
- 4.** Attach an arm or a stand to the LCD monitor securely.

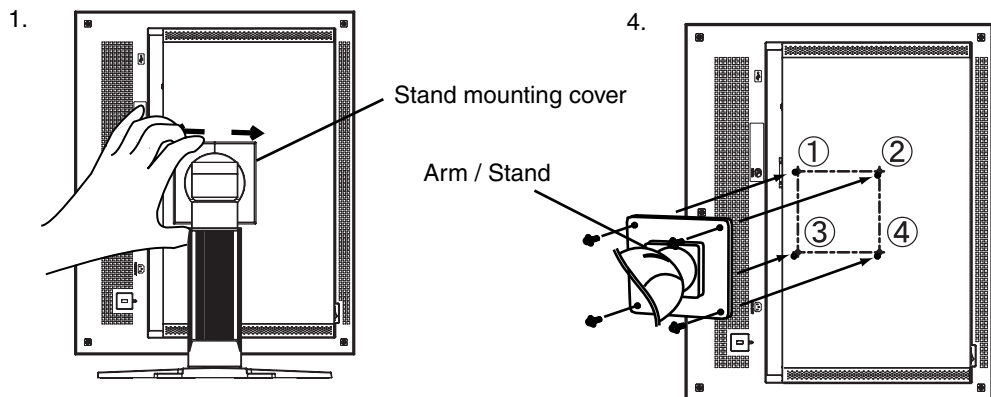

M4 Mounting Screws: M4 x 10 (mm)

# 6. TROUBLESHOOTING

If a problem persists even after applying the remedies suggested below, contact an EIZO dealer.

- No picture problems → See No.1 ~ No.2
- Imaging problems → See No.3 ~ No.6
- Other problems → See No.7 ~ No.9
- USB problems → See No.10 ~ No.11

Problem	Points to check and possible solutions
<b>1. No picture</b> <ul style="list-style-type: none"> <li>• Indicator status: Off</li> </ul>	<input type="checkbox"/> Check that the power cord is connected correctly. If the problem persists, turn off the monitor power for a few minutes, then turn it back on and try again.
<ul style="list-style-type: none"> <li>• Indicator status: Orange</li> </ul>	<input type="checkbox"/> Try pressing a key on the keyboard or clicking the mouse (p.19). <input type="checkbox"/> Try turning the PC on.
<ul style="list-style-type: none"> <li>• Indicator status: Flashing orange slowly</li> </ul>	<input type="checkbox"/> Try touching the power switch to turn it on again.
<ul style="list-style-type: none"> <li>• Indicator status: Flashing Orange (twice for each)</li> </ul>	<input type="checkbox"/> Try turning the PC on.
<b>2. The following error messages remains on the screen for 40 second.</b> <ul style="list-style-type: none"> <li>• The message appears when the signal is not input.</li> </ul> <div data-bbox="211 1128 589 1271" style="border: 2px solid black; padding: 10px; text-align: center; margin: 10px 0;"> <p>No Signal</p> </div>	<p>These messages appear when the video signal is not input correctly, even if the monitor functions properly.</p> <input type="checkbox"/> The message might appear because some PCs do not output the video signal immediately after powering on. If the image is displayed correctly after a short time, there is no problem with the monitor. <input type="checkbox"/> Check that the PC is turned on. <input type="checkbox"/> Check that the signal cable is properly connected to the PC or graphics board.
<b>3. The screen is too bright or too dark.</b>	<input type="checkbox"/> Adjust the <Brightness> (The backlight of the LCD monitor has a fixed life span. When the screen becomes dark or begins to flicker, please contact your dealer.)
<b>4. Afterimages appear.</b>	<input type="checkbox"/> Do you use the screen saver or off timer (p.17) when displaying the same image for extended periods of time? <input type="checkbox"/> Afterimages are particular to LCD monitors. Avoid displaying the same image for extended periods of time.
<b>5. The screen has defective pixels (e.g. appears slightly light or dark).</b>	<input type="checkbox"/> This is due to the characteristics of the panel itself and not the LCD product.

Problem	Points to check and possible solutions
<b>6. Fingerprints remain on the screen.</b>	<input type="checkbox"/> Leaving the screen white may solve the problem.
<b>7. The following message appears and the adjustment controls are not available when touching the switches on the control panel.</b> 	<input type="checkbox"/> After the calibration, the functions like brightness are automatically locked. Please refer to p.18 to unlock.
<b>8. The ScreenManager main menu does not operate.</b>	<input type="checkbox"/> Make sure that the adjustment lock is off (p.17). <input type="checkbox"/> Make sure the control panel switches are not wet or soiled. Lightly wipe the surface of the control panel, and try touching the switches again with dry hands. <input type="checkbox"/> Make sure not to wear gloves. Remove any gloves, and try touching the switches again with dry hands.
<b>9. The control panel does not operate.</b>	<input type="checkbox"/> Make sure the control panel switches are not wet or soiled. Lightly wipe the surface of the control panel, and try touching the switches again with dry hands. <input type="checkbox"/> Make sure not to wear gloves. Remove any gloves, and try touching the switches again with dry hands.
<b>10. The USB function does not operate.</b>	<input type="checkbox"/> Check that the USB cable is connected correctly. <input type="checkbox"/> Check that the PC and OS are USB compliant. (For verification of USB support, consult the manufacturer of each system.) <input type="checkbox"/> Check the USB setting in the PC's BIOS. (For details, refer to the manual of the PC.)



Problem	Points to check and possible solutions
<b>11. The PC freezes. The peripherals connected to the USB downstream ports do not operate.</b>	<ul style="list-style-type: none"><li data-bbox="673 204 1140 266">☐ Check that the USB cable is connected correctly.</li><li data-bbox="673 276 1222 397">☐ Try connecting the peripheral to another USB downstream port. If the problem is solved by doing this, contact an EIZO dealer. (For details, refer to the manual of the PC.)</li><li data-bbox="673 407 1222 568">☐ Try executing the following method.<ul style="list-style-type: none"><li data-bbox="707 440 934 469">- Restarting the PC</li><li data-bbox="707 475 1222 504">- Connecting the PC and peripherals directly</li></ul>If the problem is solved by doing this, contact an EIZO dealer.</li><li data-bbox="673 581 1243 728">☐ The power switch on an Apple keyboard will not operate when connected to a USB downstream port on the monitor. Connect the keyboard directly to the Apple PC. (For details, refer to the Apple PC user's manual.)</li></ul>

# 7. CLEANING

Periodic cleaning is recommended to keep the monitor looking new and to prolong its operation lifetime.

## **NOTE**

- Never use thinner, benzene, alcohol (ethanol, methanol, or isopropyl alcohol), abrasive cleaners, or other strong solvents, as these may cause damage to the cabinet or LCD panel.
- Make sure to turn off the monitor before cleaning it.

## **Cabinet**

To remove stains, wipe the cabinet with a soft, lightly moistened cloth using a mild detergent. Do not spray wax or cleaner directly into the cabinet. (For details, refer to the PC user's manual.)

## **LCD Panel**

- The LCD surface can be cleaned with a soft cloth, such as cotton or lens paper.
- For stubborn stains, use the cleaning kit “ScreenCleaner” or gently wipe the affected area using a cloth moistened with water or an ethanol-based cleaner.
- It is recommend to use the optional cleaning kit, “ScreenCleaner” (p.28). (“ScreenCleaner” is supplied with GS510-BLG/CLG.)

# 8. SPECIFICATIONS

LCD Panel	GS510-BL	54 cm (21.3 inch), TFT Monochrome LCD panel
	GS510-CL	Anti-Glare Hard Coating 2H, Response Time : approx 50ms
	GS510-BLG	54 cm (21.3 inch), TFT Monochrome LCD panel
	GS510-CLG	Hard Coating 3H, Response Time : approx 50ms
Viewing Angle		Horizontal: 170°, Vertical: 170° (CR≥10)
Dot Pitch		0.165 mm
Horizontal Scan Frequency		103.9 ± 4 kHz (only exclusive timing supported)
Vertical Scan Frequency		50.06 ± 3 Hz (only exclusive timing supported)
Resolution		5M pixels (Portrait: 2048 × 2560 dots (H × V))
Dot Clock (Max.)		142 ~ 152 MHz
Gray Scale		1024 steps of 8161 steps (10bit monochrome signal input)
Recommended Brightness		500 cd/m <sup>2</sup> (approx.70%)
Display Area		337.9 mm (H) × 422.4 mm (V) (13.3" (H) × 16.9" (V))
Power Supply		100-120/200-240 VAC±10%, 50/60 Hz, 0.9-0.7A /0.5-0.4A
Power Consumption		Min. : 80 W Max.: 85 W (With USB) Power Saving Mode: Less than 7 W (for single signal input without USB) Main power off : 0 W
Input Connector		DVI-D × 1
Input Signal		TMD5 (Single Link)
Plug & Play		VESA DDC 2B / EDID structure 1.3
Dimensions	With stand	388 mm (W) × 512.5 mm ~ 594.5 mm (H) × 208.5mm (D) (15.3" (W) × 20.2" ~ 23.4" (H) × 8.2" (D))
	Without stand	388 mm (W) × 480 mm (H) × 85mm (D) (15.3" (W) × 18.9" (H) × 3.35" (D))
Weight	With stand	9.3 kg (20.5 lbs.)
	Without stand	6.3 kg (13.9 lbs.)
Environment Conditions	Temperature	Operating: 0 °C ~ 40 °C (32 °F ~ 104 °F) Storage: - 20 °C ~ 60 °C (- 4 °F ~ 140 °F)
	Humidity	30 % to 80 % R.H. Non-condensing
	Pressure	Operating: 700 to 1,060 hPa Storage: 200 to 1,060 hPa
USB	Standard	USB Specification Revision 2.0
	USB ports	Upstream port × 1, Downstream port × 2
	Communication Speed	480 Mbps (high), 12 Mbps (full), 1.5 Mbps (low)
	Power Supply	Downstream: 500 mA for each (Max.)
Classification of Equipment		Type of protection against electric shock: Class I EMC class: EN60601-1-2: 2001 Group 1 Class B Classification of medical device (MDD 93/42/EEC): Class I

## Dimensions

mm (inches)

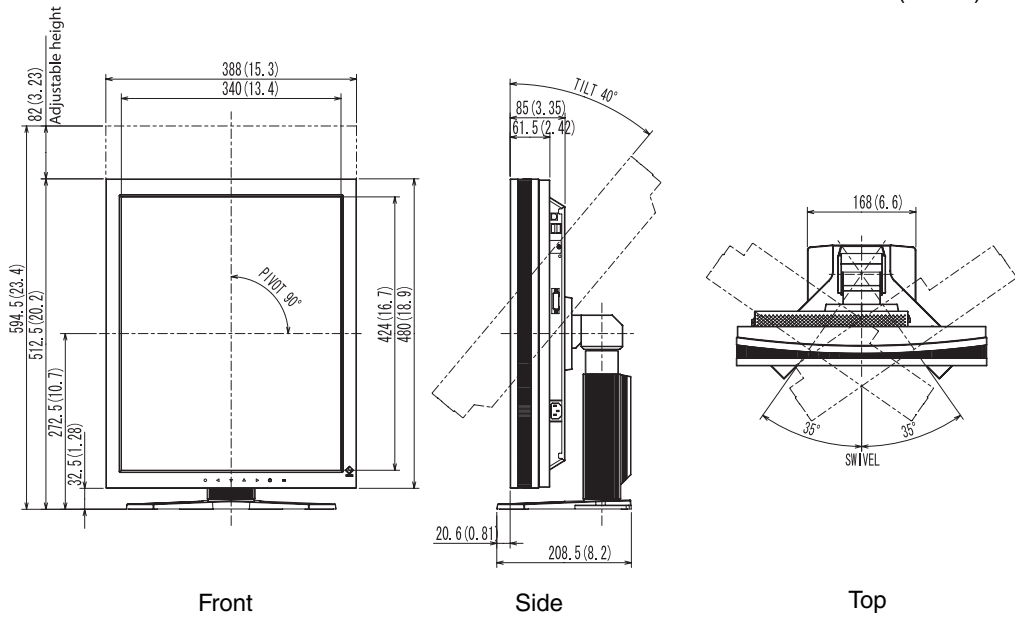

## Default Settings

Brightness		Fixed at the factory
Orientation		Portrait
PowerManager		DVI DMPM
Off Timer		Disable
Menu Settings	Menu Position	Center
	Menu Off Timer	45 seconds
Language		English

## Optional

Panel Protector	EIZO "RP-901"
Arm, Stand	EIZO "LS-HM1-D": Dual Height Adjustable Stand EIZO "LA-131-D": LCD Monitor Flexible Arm EIZO "LA-030-W": Wall Mount Arm for LCD Monitor EIZO "LA-011-W": Wall Mount Arm for LCD Monitor
Graphics board	8bit and 10bit monochrome signals supported <ul style="list-style-type: none"> <li>• RealVision "VREngine/SMD5-PCI"</li> <li>• Matrox "MED5mp-PPP"</li> </ul>
Calibration Kit	EIZO "RadiCS GX2" Ver.2.3.0 or later EIZO "Clip-On Swing Sensor G1"
Network QC Management Software	EIZO "RadiNET Pro" Ver.2.3.0 or later
Cleaning kit	EIZO "ScreenCleaner"

## Pin Assignment

### DVI-D Connector

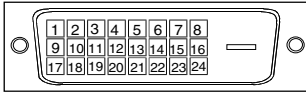

Pin No.	Signal	Pin No.	Signal	Pin No.	Signal
1	TMDS Data2-	9	TMDS Data1-	17	TMDS Data0-
2	TMDS Data2+	10	TMDS Data1+	18	TMDS Data0+
3	TMDS Data2/4 Shield	11	TMDS Data1/3 Shield	19	TMDS Data0/5 Shield
4	NC*	12	NC*	20	NC*
5	NC*	13	NC*	21	NC*
6	DDC Clock (SCL)	14	+5V Power	22	TMDS Clock shield
7	DDC Data (SDA)	15	Ground (For +5V)	23	TMDS Clock+
8	Analog Vertical Sync	16	Hot Plug Detect	24	TMDS Clock-

(\*NC: No Connection)

### USB Port

Upstream    Downstream

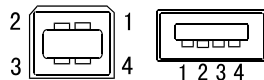

Series B    Series A

No.	Signal	Remarks
1	VCC	Cable power
2	- Data	Serial data
3	+ Data	Serial data
4	Ground	Cable Ground

# 9. GLOSSARY

## **DVI**

(Digital Visual Interface)

A digital flat panel interface. DVI can transmit digital data without loss and directly from the PC using the signal transition method “TMDS” (p.30).

There are two kinds of DVI connectors: the DVI-D connector for digital signal input only, and the DVI-I connector for both digital and analog signal inputs.

## **DVI DMPM**

(DVI Digital Monitor Power Management)

The Power management system for the digital interface. The “Monitor ON” status (operation mode) and the “Active Off” status (power-saving mode) are indispensable for the DVI-DMPM as the monitor's power mode.

## **LUT**

(Look-up table)

Look-up table is the compensation data, to which the monitor refers, when the monitor outputs the input data from a graphics board. In this model, the “Default\*” adjusted beforehand referring to look-up table at a factory or “Normal”, which is in the state of the characteristic of panel original, (i.e. not adjusted) can be available.

“Custom” automatically stores the customized data after the calibration is performed.

\*“Default” is adjusted with the factory default brightness to DICOM grayscale standard.

## **Resolution**

The LCD panel consists of a fixed number of pixel elements which are illuminated to form the screen image. The EIZO GS510-BL/CL/BLG/CLG display panel consists of 2048 horizontal pixels and 2560 vertical pixels. At a resolution of 2048 x 2560, all pixels are displayed as a full screen.

## **TMDS**

(Transition Minimized Differential Signaling)

A signal transition method for the digital interface.

For U.S.A, Canada, etc. (rated 100-120 Vac) Only

---

## FCC Declaration of Conformity

We, the Responsible Party

EIZO NANA O TECHNOLOGIES INC.  
5710 Warland Drive, Cypress, CA 90630  
Phone: (562) 431-5011

declare that the product

Trade name: EIZO  
Model: RadiForce GS510

is in conformity with Part 15 of the FCC Rules. Operation of this product is subject to the following two conditions: (1) this device may not cause harmful interference, and (2) this device must accept any interference received, including interference that may cause undesired operation.

This equipment has been tested and found to comply with the limits for a Class B digital device, pursuant to Part 15 of the FCC Rules. These limits are designed to provide reasonable protection against harmful interference in a residential installation. This equipment generates, uses, and can radiate radio frequency energy and, if not installed and used in accordance with the instructions, may cause harmful interference to radio communications. However, there is no guarantee that interference will not occur in a particular installation. If this equipment does cause harmful interference to radio or television reception, which can be determined by turning the equipment off and on, the user is encouraged to try to correct the interference by one or more of the following measures.

- \* Reorient or relocate the receiving antenna.
- \* Increase the separation between the equipment and receiver.
- \* Connect the equipment into an outlet on a circuit different from that to which the receiver is connected.
- \* Consult the dealer or an experienced radio/TV technician for help.

Changes or modifications not expressly approved by the party responsible for compliance could void the user's authority to operate the equipment.

### Note

Use the attached specified cable below or EIZO signal cable with this monitor so as to keep interference within the limits of a Class B digital device.

- AC Cord
- Shielded Signal Cable (enclosed)

---

## Canadian Notice

This Class B digital apparatus complies with Canadian ICES-003.

Cet appareil numérique de la classe B est conforme à la norme NMB-003 du Canada.

**Recycling Information for customers in EU:**

All recycling information is placed in the following websites.

**Recycling-Information für Kunden in Europa:**

Alle Informationen zum Thema Recycling finden Sie auf den folgenden Websites:

**Informations sur le recyclage pour les clients dans l'UE:**

Vous trouverez toutes les informations sur le recyclage dans les sites Web suivants:

**Återvinningsinformation för kunder i EU:**

All information om återvinning finns på följande webbsidor:

<http://www.swico.ch>

<http://www.eizo.de>

<http://www.eizo.se>

**Recycling Information for customers in USA:**

All recycling information is placed in the Eizo Nanao Technologies, Inc.'s website.

<http://www.eizo.com>





## **EIZO NANA O CORPORATION**

153 Shimokashiwano, Hakusan, Ishikawa 924-8566 Japan  
Phone: +81 76 277 6792 Fax: +81 76 277 6793

## **EIZO NANA O TECHNOLOGIES INC.**

5710 Warland Drive, Cypress, CA 90630, U.S.A.  
Phone: +1 562 431 5011 Fax: +1 562 431 4811

## **EIZO EUROPE AB**

Lovangsvagen 14 194 61, Upplands Väsby, Sweden  
Phone: +46 8 590 80 000 Fax: +46 8 590 91 575

## **EIZO NANA O AG**

Moosacherstrasse 6, Au CH - 8820 Wadenswil, Switzerland  
Phone: +41-0-44 782 24 40 Fax: +41-0-44 782 24 50

## **Avnet Technology Solutions GmbH**

Lötscher Weg 66, D-41334 Nettetal, Germany  
Phone: +49 2153 733-400 Fax: +49 2153 733-483

## **株式会社ナナオ**

〒924-8566 石川県白山市下柏野町153番地

**This document is printed on recycled chlorine free paper.**

<http://www.radiforce.com>

1st Edition-July, 2006 Printed in Japan.

00N0L235A1  
(GS510-AL)